

Windows define and express the style and architectural period of a building through such details as molding profiles, function, size, shape, position, and glazing patterns. Retaining the original windows is one of the best ways to retain the charm, character, and resale value of an older building.

Design Review Requirements

Any significant changes to the existing windows will require a Design Review. This includes, but is not limited to:

- Any substantial change in size of the window
- Installing a new window to the home
- Installing a new window style that is not considered a restoration

Please submit a hardcopy of the following for a Design Review or a Building Permit:

- Permit Application
- Photograph(s) of the existing window(s) to be replaced
- A brochure of the new replacement window for details such as the window manufacturer and if applicable, model number or style name, e.g. "Marvin Integrity"
- A cross-section of the new windows – usually available from the supplier, brochure, or use the drawings in Attachment 2. If you use the drawings and your proposal is different from the drawings mark up the drawings to show the difference.
- A site plan or floor plan clearly identifying the location(s) of all new replacement window(s)
- A complete window schedule with numbers or letters (i.e. A, B, C, or 1, 2, 3) corresponding to the window locations on the floor or site plan. See Window Schedule.
- A Home Owners Association approval letter if the home is located within an area subject to home owner association design approval

Design Review Exemptions

Replacement windows are exempt from Design Review if there is no change in size of the opening and either:

- **Replacement "In-Kind"**. If the existing windows are part of the original construction of the house, the replacement window shall visually match the existing windows, including having the dimensions typical of the original window (see *Typical Dimensions* as well as the Design Review Ordinance.); or
- **Restoration**. If restoring previously altered windows, the replacement windows are consistent with the building's original architectural style (see *Stylistic Consistency Chart*) and visually match the types of windows that would have been used originals (see *Stylistic Consistency Chart* and *Typical Dimensions*).

For more details on window replacement regulations, please refer to "Section III – Building Materials & Detailing" of the *Guide to Residential Design* on the City's website.

Restoration of Previously Altered Windows

Identify the style of the building and either:

- Use the Stylistic Consistency guide to determine the type, material and design of the new windows, or
- Select other buildings of the same style with original windows; use these windows as models for the restored windows and include photographs of the other buildings with your submittal; or
- If old photographs or plans are available, base the new windows on the photographs or plans and include the photographs or plans in your submittal.

Visually Matching Replacement Windows with Existing or Restored Original Windows

Choose a window that matches type and size of the original windows or, if the original window has been replaced, a window consistent with the building's original architectural style (see *Stylistic Consistency Chart*).

Choose a window that has dimensions typical of the original windows (see *Typical Dimensions of Wood and Steel Windows*).

Replacement windows do not have to be made of the same material (i.e. wood) as the original as long as the visual character of the new windows matches that of the originals. But if the existing or original windows were wood, and if the new window material is different, surfaces must be smooth and flat (not molded), and finishes flat semi-gloss (not gloss).



STYLISTIC CONSISTENCY CHART



For Pre-1960s Buildings

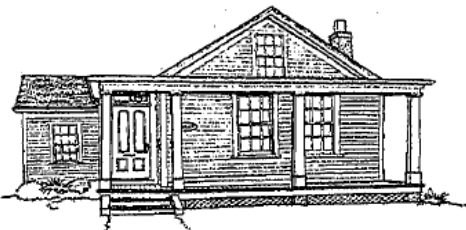
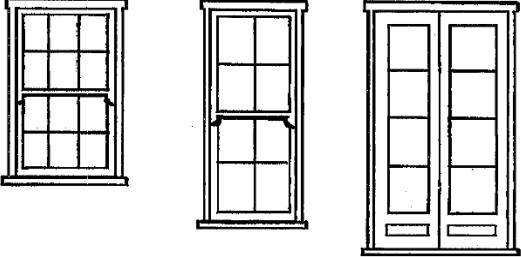
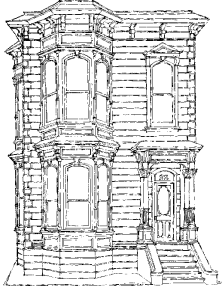
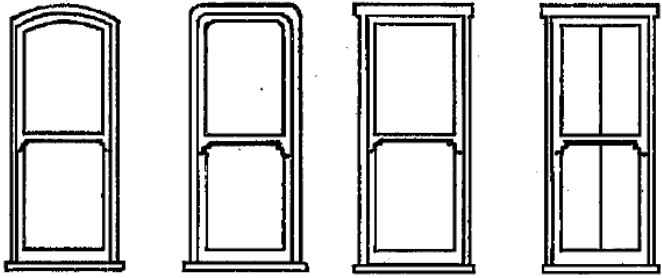

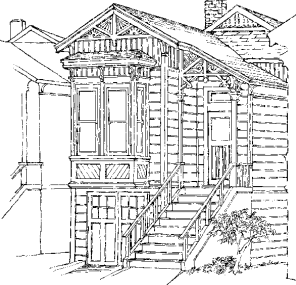
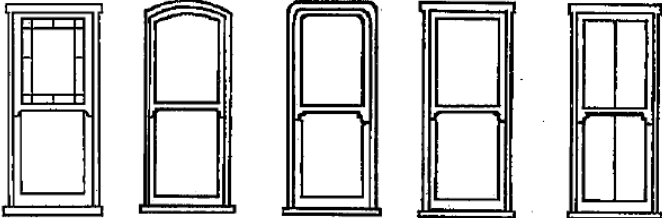
To find the window with the best visual match to the original window, locate your building's architectural style (Column 1) and then review the typical window and muntin types to guide your window replacement decision. If a building has more than one architectural style as shown in the chart, the new windows can relate to any of these styles.

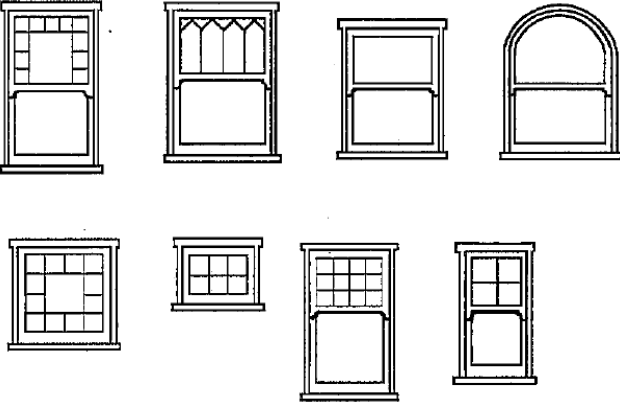
Instead of using the Stylistic Consistency Chart, you can choose window types and designs from original windows on other Alameda buildings with the same style as your building.

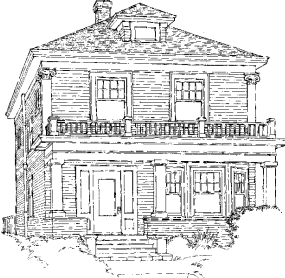
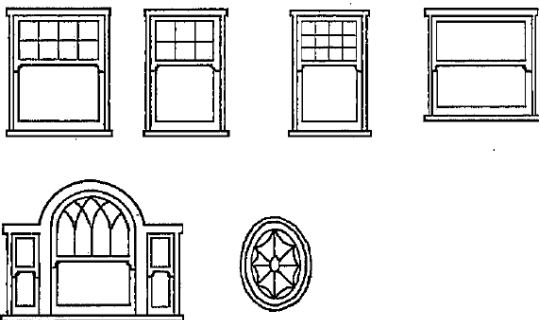
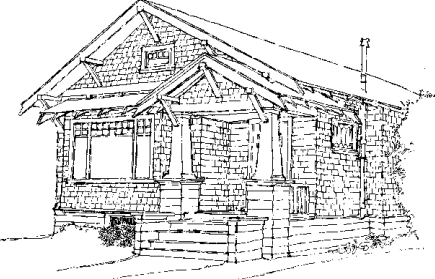
| Architectural Style of Building | Typical Original Windows | | | |
|---|--------------------------|-----------|---|--|
| | Type | Materials | Muntin Patterns | Comments |
| Pioneer (18402 – 1860s)  | Double hung. | Wood. |  Muntins: Yes | Besides double hung wood sash, wood French doors opening out onto porches and balconies were sometimes constructed. |
| Italianate (1870s – 1880s)  <small>© City of Oakland</small> | Double hung. | Wood. |  Muntins: Sometimes (usually only at the rear) | Window openings are tall and narrow, enhancing verticality of facades. Curved and arched upper sashes are common. Transom lites over doors are common. |

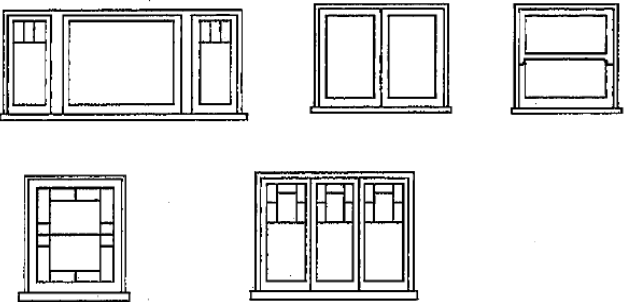
| Architectural Style of Building | Typical Original Windows | | | |
|---|--------------------------------|--------------|--|--|
| | Type | Materials | Muntin Patterns | Comments |
| <p>Stick/Eastlake (1880s)</p>  <p>© City of Oakland</p> | <p>Double hung. Fixed.</p> | <p>Wood.</p> |  <p>Muntins: Rarely</p> | <p>Stick/Eastlake and Italianate windows are very similar, except Stick/Eastlake are usually not arched. Fixed windows are usually only over stairs, near entries and in attic gable ends and dormers.</p> |
| <p>Queen Anne (1880s – 1890s)</p>  <p>© City of Oakland</p> | <p>Double hung. Fixed.</p> | <p>Wood.</p> |  <p>Muntins: Often</p> | <p>Many window forms, shapes, and sizes. Complex muntin patterns are common. Stained glass is common. Horizontally curved sash in round towers is common. Fixed windows at same locations as for Stick/Eastlake.</p> |

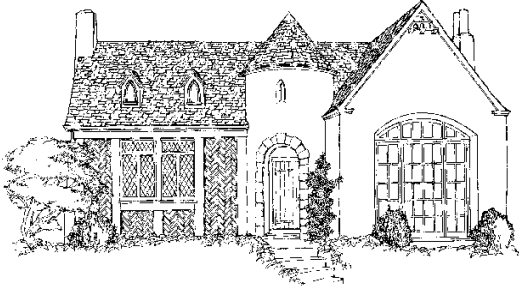
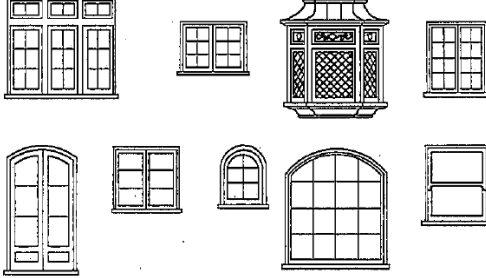
| Architectural Style of Building | Typical Original Windows | | | |
|---|-------------------------------------|-------------------------------------|---|--|
| | Type | Materials | Muntin Patterns | |
| Colonial Revival (1890s – 1950s) and Eastern Shingle (1890s – 1910s)  <small>© City of Oakland</small> | Double hung. Casement. Fixed. | Wood. Steel (1920s – 1950s only) |  Muntins: Sometimes | In Alameda, muntins are usually only on upper sash of double-hung windows, except post-1920 Colonial Revival. Upper sash is often shorter than lower sash. Sometimes stained or leaded glass is in upper sash or transoms and fixed sash is near fireplaces and entries and in dining rooms. |
| Craftsman (1900s – 1920s)  <small>© City of Oakland</small> | Double hung. Casement. Fixed. | Wood. |  Muntins: Usually (recommended) | Living and dining rooms often have a three-part window with a fixed middle sash and casement or double-hung sidelights. See Colonial Revival for stained and leaded glass and fixed sash treatments. |
| Prairie (1900s – 1920s)  <small>© City of Oakland</small> | Double hung. Casement. Fixed. | Wood. |  Muntins: Usually (recommended) | Windows often feature larger sizes of glass than seen in earlier styles. Windows and sash groupings emphasize horizontality. See Colonial Revival for stained and leaded glass and fixed sash treatments. Three-part window treatments same as Craftsman. |

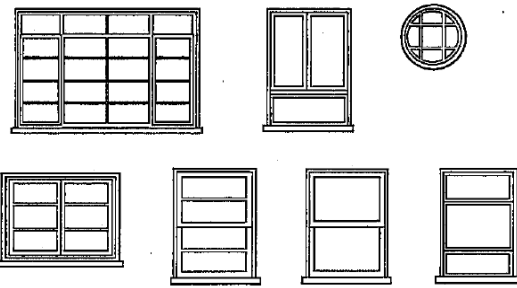
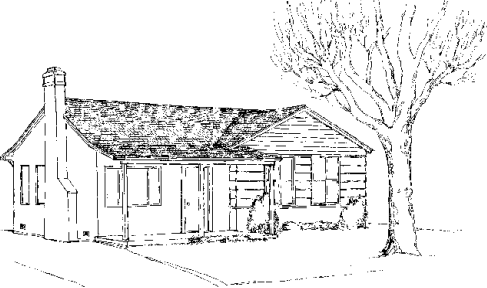
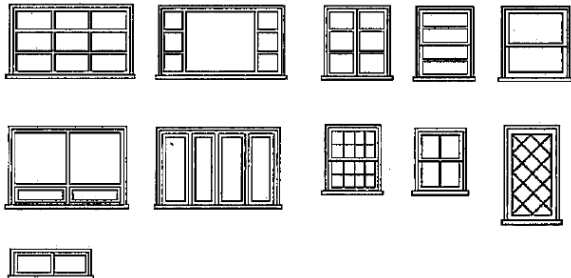
| Architectural Style of Building | Typical Original Windows | | | |
|--|---|--|---|---|
| | Type | Materials | Muntin Patterns | Comments |
| Provincial (1920s – 1940s) and Tudor (1900s – 1940s)  <small>© City of Oakland</small> | Double hung. Casement. Fixed. | Wood. Steel (1920s and later) |  Muntins: Usually (recommended) | Three-part window treatments same as Craftsman. Sometimes leaded glass, usually in a diamond pattern. |
| Streamline Moderne (1930s – 1950s)  <small>© City of Oakland</small> | Double hung. Casement. Awning. Vent. Louver. Horizontal sliders. | Wood. Steel. Aluminum. Glass block. |  Muntins: Yes | Muntin patterns are usually horizontal, rather than vertical as seen in earlier architectural styles. |
| Ranch and Midcentury Modern (1940s – 1950s)  <small>© City of Oakland</small> | Double hung. Casement. Fixed. Horizontal sliders. | Wood. Steel. Aluminum. |  Muntins: Sometimes | Muntin patterns more horizontally oriented. Larger sizes of glass in each lite. Three-part window treatments same as Craftsman. |

Copyrighted building illustrations are from [Rehab Right: How to Realize the Full Value of Your Old House](#) by Kaplan and Prentice, City of Oakland Planning Department

TYPICAL DIMENSIONS OF WOOD AND STEEL WINDOWS

Note on internal muntins/grids: Internal muntins or grids began to be used in the late 1970s. On double glazed windows (consisting of two sheets of glass separated by an airspace) they are sandwiched within the air space between the glass sheets. They are also sometimes used on just the interior face of the glass, but not the exterior. Windows with internal muntins/grids are exempt from Design Review only if they replace original windows which have internal muntins/grids, such as those found at Harbor Bay Isle.

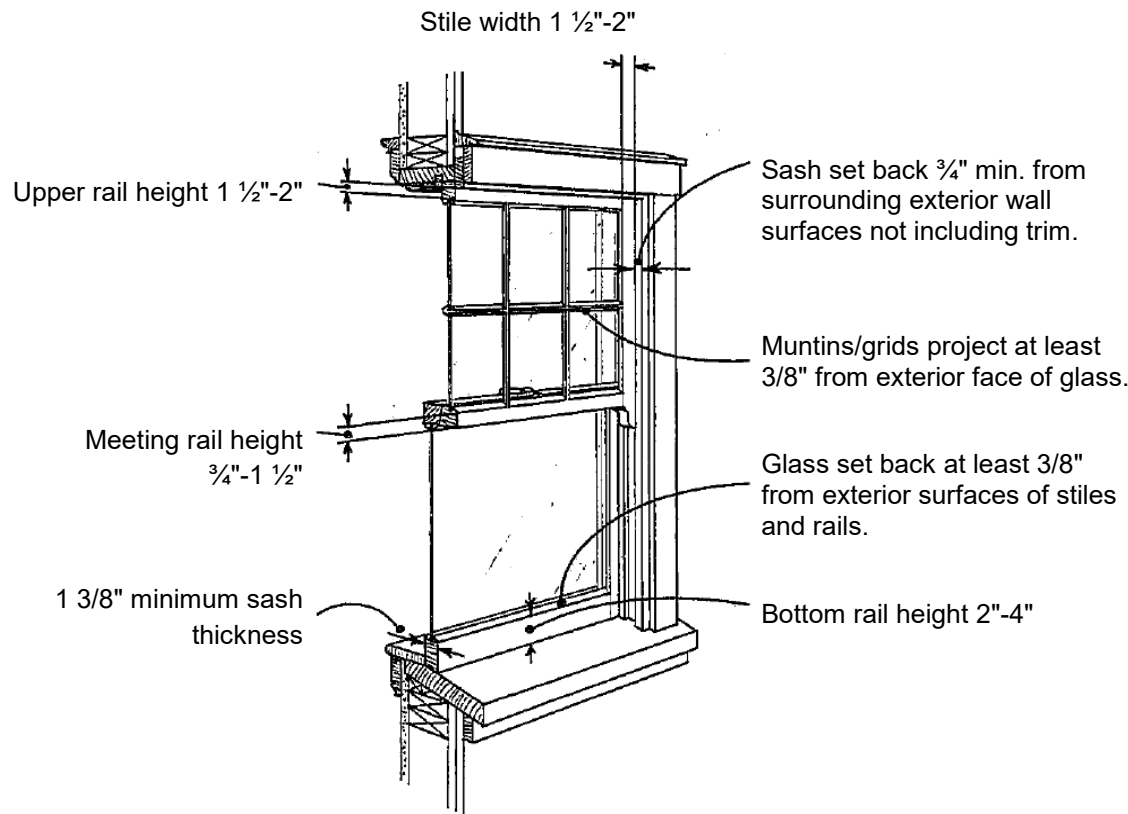

Wood Double Hung Sash
Typical Dimensions

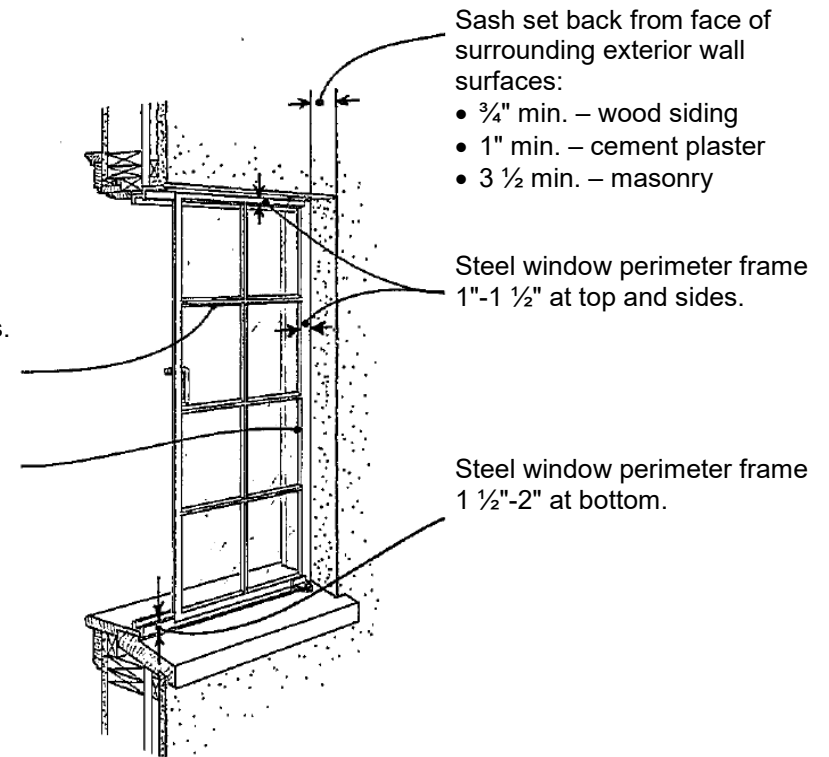

Steel Casement Sash
Typical Dimensions

REQUIRMENTS FOR REPLACING BEDROOM WINDOWS IN EXISTING HOMES

Minimum of one (1) window per bedroom unless there is a door to the exterior.

Many fire-related casualties occur when occupants of residential buildings are asleep at the time of the fire. Section 310.4 of the California Building Code requires that:

Basements in dwelling units and every sleeping room below the fourth story shall have at least one operable window or door approved for emergency escape or rescue that shall open directly into a public street, public alley, yard or exit court. The emergency door or window shall be operable from the inside to provide a full, clear opening without the use of separate tools.

1. The net clear opening shall have a minimum net clear openable area of 5.7 square feet.
2. The minimum net clear open width dimension shall be 20 inches.
3. The minimum net clear open height dimension shall be 24 inches.
4. The finished sill height shall not be more than 44 inches above the floor.

| Year House Constructed | Does CBC require bedroom egress? | Net Opening Size | Minimum Opening Dimensions (see below) | Sill Height (maximum from finished floor) |
|------------------------|----------------------------------|------------------|---|--|
| Prior to 1964 | Yes | 3.3 sq. ft. | 18 inches – height 18 inches - width | 48 inches |
| 1964 to 1969 | Yes | 5 sq. ft. | 24 inches – height 24 inches - width | 48 inches |
| 1970 to 1975 | Yes | 5 sq. ft. | 22 inches – height 22 inches – width | 48 inches |
| 1976 to Present | Yes | 5.7 sq. ft. | 24 inches – height 20 inches – width | 44 inches |

| Minimum Opening Sizes of at Least One (1) Bedroom Window to Meet Requirements for Emergency Escape and Rescue (in inches) | | | | | | | | | | | | | | | |
|---|------|------|------|------|------|------|------|------|------|------|------|------|------|------|------|
| Width | 20.0 | 20.5 | 21.0 | 21.5 | 22.0 | 22.5 | 23.0 | 23.5 | 24.0 | 24.5 | 25.0 | 25.5 | 26.0 | 26.5 | 27.0 |
| Height | 41.0 | 40.0 | 39.1 | 38.2 | 37.3 | 36.5 | 35.7 | 34.9 | 34.2 | 33.5 | 32.8 | 32.2 | 31.6 | 31.0 | 30.4 |
| Width | 27.5 | 28.0 | 28.5 | 29.0 | 29.5 | 30.0 | 30.5 | 31.0 | 31.5 | 32.0 | 32.5 | 33.0 | 33.5 | 34.0 | 34.2 |
| Height | 29.8 | 29.3 | 28.8 | 28.3 | 27.8 | 27.4 | 26.9 | 26.5 | 26.1 | 25.7 | 25.3 | 25.1 | 24.9 | 24.1 | 24.0 |

Remember to allow for frame size when measuring width and height. Formula to calculate window square footage: width x height over by 144 (in inches)

WINDOW SCHEDULE

Site Address: _____ Year Built: _____ Is property on City Study List or a City Monument: Yes No

Architectural Style of Building: Pioneer Italianate Stick Eastlake Queen Anne Colonial Revival Craftsman
 (Check all that apply) Bungalow Prairie Mediterranean Provincial Tract/Ranch Other

| | ROOM | EXISTING WINDOW TYPE | NEW WINDOW TYPE | EXISTING WINDOW MATERIAL | NEW WINDOW MATERIAL | EXISTING SIZE <i>(width) x (depth)</i> | NEW SIZE <i>(width) x (depth)</i> | MUNTINS/ GRIDS |
|--------------|----------------|----------------------|-----------------|--------------------------|-------------------------------------|---|--------------------------------------|--|
| Ex- ample | <i>Kitchen</i> | <i>Double-hung</i> | <i>Casement</i> | <i>Wood</i> | <i>Alum-Clad with Wood core</i> | <i>48" x 36"</i> | <i>96" x 72"</i> | <i>3/4" x 1/4" (width) x (depth)</i> |
| 1* | | | | | | | | |
| 2 | | | | | | | | |
| 3 | | | | | | | | |
| 4 | | | | | | | | |
| 5 | | | | | | | | |
| 6 | | | | | | | | |
| 7 | | | | | | | | |
| 8 | | | | | | | | |
| 9 | | | | | | | | |
| 10 | | | | | | | | |
| 11 | | | | | | | | |
| 12 | | | | | | | | |
| 13 | | | | | | | | |
| 14 | | | | | | | | |
| 15 | | | | | | | | |
| 16 | | | | | | | | |

*** Please show these window numbers on the project plans. Continue on another sheet if your project exceeds 16 window replacements.**